

A NOVEL CURRENT-FED SWITCHED INVERTER WITH COUPLED INDUCTOR FOR LOW VOLTAGE PV APPLICATIONS

Gaayathry K

Dr. Girirajkumar S.M

Assistant Professor, Department of EEE, Saranathan College of Engineering, Trichy.

Professor & Head, Department of ICE, Saranathan College of Engineering, Trichy.

E-mail : gaaykrish@gmail.com, smgirirajkumar@gmail.com

Abstract: *The Renewable Energy Sources such as Wind Energy, Fuel Cell, Uninterruptible Power Supply (UPS) and Solar Photovoltaic (PV) Systems produces DC output. By considering the above energy sources with DC, it is essential to analyze about DC-DC Converters. The DC-DC Boost Converter topologies have the demerits such as power from Renewable Sources are not transferred individually and simultaneously, Poor Electric Isolation, so not suitable for high power application, Complex construction due to more number of components and related gate driver circuits and asymmetrical structure will lead to difficult power flow control. Then, for conversion of low level DC input voltage to high level DC output voltage, Boost Converters are used. It possess continuous operation and better efficiency, due to existence of single switch. The output voltage can be stabilized by proper selection and design of input side Inductor and output side Capacitor. To optimize the performance and efficiency of the system, the correct Inverter has to be selected, for DC-AC Conversion. The coveted properties of an Inverter for efficient AC inversion are elevated Step-up and Step-down competencies and Shoot-through invulnerability. The Inverters are significantly characterized into Current Source Inverter (CSI) and Voltage Source Inverter (VSI). This paper deals with Current Fed Switched Inverter (CFSI) topology, whereupon, it possess the property of elevated gain in Z-Source Inverter and enervated count of passive component of Switched Boost Inverter (SBI). The propounded Inverter consists of increased boost ability with surpassing Electromagnetic Interference (EMI) immunity equated to a conventional VSI. This paper proposes an advanced high boost CFSI topology based on Coupled Inductor, procured from conventional CFSI, whereupon can be used for low-voltage Renewable Energy Systems, where increased step-up voltage is essential to interact with AC systems with the ratings of 110 to 220 v and featured with high voltage gain than the existing Z-Source Inverter (ZSI) and Switched Boost Inverter (SBI). The utilization of Coupled Inductors lessens the Inverter volume and extreme current streaming. Pulse Width Modulation (PWM) strategy is formulated for the propounded Inverter. The Simulation is done using MATLAB/Simulink. An Experimental prototype is developed to validate the performance of the propounded Inverter.*

Keywords: *Renewable Energy Sources, Boost Converter topologies, Current Fed Switched Inverter (CFSI), Coupled Inductor.*

1. Introduction:

Now-a-days, the entire Universe is more conscious about the environmental issues related to Fossil fuel Exhaustion and Non-Renewable Energy Sources. Hence, Renewable Energy Sources (RES), are flattering more familiar and Solar Energy assumes an essential part in it [1]. The VSIs are generally used in UPS, PV and fuel cell applications. But, Conventional VSIs [2] possess only buck operation and cannot perform shoot-through operation. As the voltage of the PV panel's voltage is less, Inversion of high boost is essential. Either Step-up Transformer or Two Stage Boost Inverter topology can be utilized for this reason. But, it is better to apply transformer-less Conversion Topologies [3]-[5], when considering Overall cost, size and efficiency of the circuit. When VSI follows a high-gain DC-DC boost topology, it is known as Two-stage Conversion. In the DC - DC stage, output is voltage stiff. EMI is the main drawback related with two-stage Inversion of DC - AC. EMI will lead to glitch of the inverter operation and damage to inverter switches. To eradicate these VSI stumbling blocks, ZSI, Quasi-ZSI (q-ZSI) [6], SBI [7]-[9], Trans-ZSI [10], were proposed. Then, CFSI [11]-[12] was proposed which correlates the property of low count of passive components as SBI and with high gain as same as ZSI. It is a high-gain Inverter which does not require dead band for switching pulses. In CFSI, both Step-up and Step-down operations are feasible and it possess continuous input current, so it suits for PV applications.

This paper proposes an advanced CFSI with Coupled Inductor, LC filter and reduced number of switches (MOSFETs) and to achieve high boost, it uses energy transmit through the transformer activity of Coupled Inductor. The Coupled Inductor, Switched Inductor and Switched Capacitor can be used to improve the boost factor of the Inverter, because by reducing the count of components, or through continuous flow of input current and less stress in device, we cannot attain the high efficiency, ease of integration and low device cost in Renewable Sources. In the Next Section, the Conventional ZSI, SBI topologies are reviewed. In Section III, the CFSI topology – Review is described. In Section IV, The advancement of proposed CFSI topology is discussed in detail. Section V gives the Simulation results of the propounded Inverter. And in Section VI, it is validated with experimental results. In Section VII, Accomplishment remarks of this paper are described.

2. Conventional Topologies: Z - Source Inverter (ZSI):

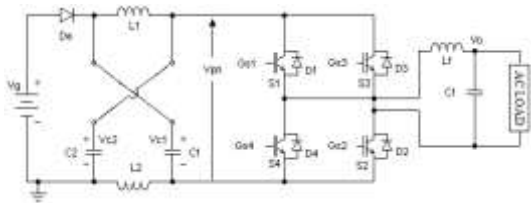

Fig. 1. Schematic Diagram of ZSI

The ZSI was designed [3] with the capability of buck-boost operation for Single-stage DC to AC inversion. The Fig. 1. represents the schematic diagram of ZSI. This diagram consists of an “X” – shaped impedance network and a diode between the DC source and the Inverter. The Boost factor of ZSI is formulated as,

$$B_{ZSI} = \frac{V_{pn}}{V_g} = \frac{1}{1-2D} \quad \text{---} \quad (1)$$

whereas,

V_{pn} – Peak input voltage of Inverter

V_g – DC Input voltage

D – Shoot-through duty ratio (The Interval in which both switches of any leg of the inverter conduct).

Though, the input is a switched voltage to ZSI, shoot - through operation is applicable and it is also helpful for attaining better Electro-Magnetic Interference (EMI) immunity.

Switched Boost Inverter (SBI):

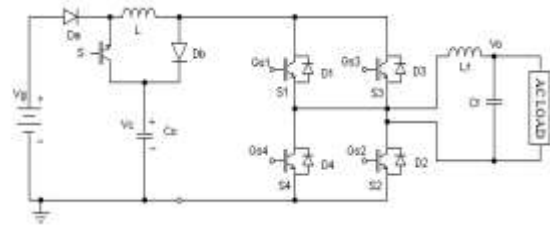

Fig. 2. Schematic Diagram of SBI

The schematic of SBI was designed by keeping up a similar effectual conditions of the ZSI yet diminishing the count of passive components by using the active network [7]-[9] instead of “X” – shaped impedance network. As same as this Inverter, SBI additionally comprises of better EMI noise immunity. The Fig. 2. represents the schematic diagram of SBI which consists of one L-C pair which makes it a compact solution due to its depletion in weight, size and cost. The boost factor of this inverter is (1-D) times that of ZSI and it is considered as a main demerit. Hence, it does not suits very high boost inversion operation. The gain value is maximum near $D = 0.5$ for both ZSI and SBI.

3. CFSI Topology – Review:

This section demonstrates about a current fed DC/DC topology (CFT) based Inverter which is named as Current fed Switched Inverter (CFSI).

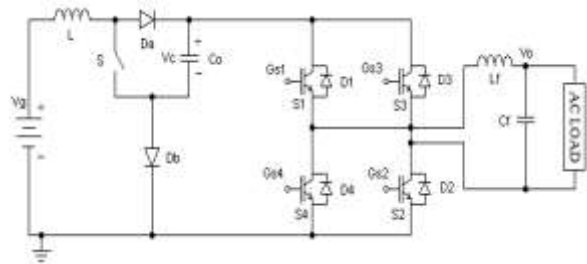

Fig. 3. Schematic Diagram of CFSI

The diagrammatic representation of CFSI is shown in Fig. 3. The CFSI [11]-[12] topology consists of main components such as one dynamic switch (S), two diodes (D1,D2),one capacitor (C) and one Inductor (L) and all these are associated in the middle of the input voltage (V_g) and the Inverter bridge circuit. The output of the bridge circuit associated with a low pass L-C filter, which helps to eradicate the high frequency components in the Inverter’s output. The shoot - through state operation is possible in CFSI, so the dependability of the inverter is enhanced. Thus, the inverter produces single-stage DC-AC output with elevated efficiency.

As same as ZSI and SBI [14]-[17], the intake to the inverter is a switched voltage.

The CFSI operating states are classified into Shoot through state and Non-Shoot through state, the later can be further classified into active and zero state i.e (power and zero interval of the inverter). During the shoot through or duty interval (D), Switches (S) and S1,S2 or S3,S4 of the inverter leg is turned on. Now, Inductor (L) is charged by both Source (Vg) and Capacitor (Co), combinedly. During the non-shoot through or (1-D) or D' interval, Diodes D1,D2 is turned on, while S is switched off, then the Co is charged by L and it delivers power to AC-load via the inverter.

The voltage across L in one switching period, Ts is given as,

$$V_L = \left\{ \begin{array}{ll} V_g + V_c & \text{During } D.T_s \\ V_g - V_c & \text{During } (1-D).T_s \end{array} \right\} \quad \text{--- (2)}$$

$$B_{CFSI} = \frac{V_c}{V_g} = \frac{1}{1-2D} \quad \text{--- (3)}$$

Though, the high boost output is possible in CFSI, the shoot through state operation controls the modulation index value to inevitably less than (1-D). This induces higher emphasize on the inverter switches. In the upcoming section, the proposed Coupled Inductor based CFSI topology will be discussed and analyzed which will reduce the demerits of CFSI as mentioned above.

4. Development of Proposed CFSI Topology:

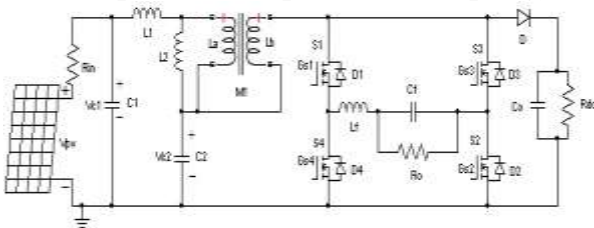

Fig. 4. Schematic Diagram of Proposed CFSI

The Schematic diagram of proposed Coupled – Inductor [18]-[20] based CFSI is displayed in the Fig. 4. The proposed Coupled – Inductor based CFSI consists of Single-stage high-boost Inversion process along with continuous input which is appropriate for the Renewable Energy Applications [21]-[22]. The magnetic integration of Inductor (Coupled Inductor) can be done by coupling the Inductors using one core. This technique is useful to reduce the magnetic volume and size of the Converter and to attain high voltage gain. The

Coupled – Inductor having high turns ratio helps for obtaining higher boosting gains.

The proposed Inverter comprises of a functioning impedance which incorporates Photovoltaic (PV) panel as input DC Source, Input Resistance (Rin), Coupled – Inductor La and Lb with n1 primary and n2 secondary turns combinedly n-turns ratio, Inductors (L1,L2), Capacitors (C1,C2), which comes before the single phase Inverter bridge circuit. In the Coupled – Inductor, the secondary winding number of turns (n2) is less than the primary winding number of turns (n1) for proper Inverter operation. The proposed Coupled – Inductor based CFSI topology uses the transfer of energy through the transformer activity of the Coupled – Inductor to attain increased voltage, which relies upon the turns ratio (n1: n2). Generally, one switch is used in the Impedance network side and the Inverter switches are used separately. In this Inverter, two L-C filters (Input and Output) are used. A low pass LC filer connected at the output side of the inverter bridge circuit is used to riddle the switching frequency elements in the output side voltage of the inverter. The shoot-through state is avoided because of not using any other switches except in Inverter. Here, in the proposed CFSI, the switch at impedance network is eliminated and only the Diode is used. The Diode is placed after the Inverter switches. In this, two modes of operation will take place. During mode-1, the Switches S1, S2 will get turned on and S3,S4 remains off in condition and the diode, D conducts. During mode-2, the Switches S3,S4 will get turned on and S1,S2 remains off in condition. The input voltage is calculated from PV panel. The FPGA based PWM scheme is integrated in the proposed CFSI for the PWM control. Here the input voltage is 16 v and to reduce the switching losses, the switching devices is selected as MOSFET.

5. Simulation Results of Proposed Inverter:

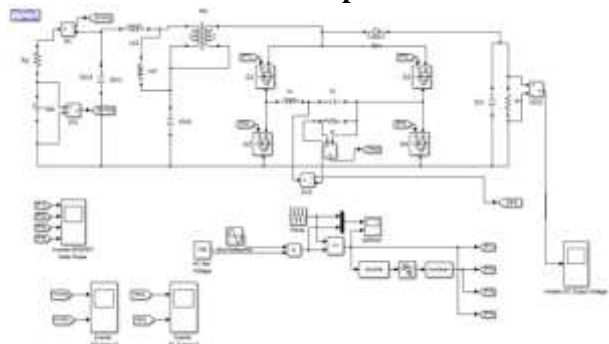

Fig. 5. Simulink Diagram of Proposed CFSI

The proposed Inverter has been simulated in MATLAB/Simulink. The Simulink diagram of the propounded Inverter is shown in Fig. 5. The improved CFSI circuit with input DC voltage of 16 v is mapped out and simulated to validate the proposed concept to obtain AC output voltage as 107.9 v. The Duty cycle value is 0.483 and the modulation index is 0.9. For the MATLAB Simulation, the parameters for proposed inverter are used as follows:

Table I Simulation Parameters of Proposed CFSI

PARAMETERS	SPECIFICATIONS
Input voltage of PV panel (V_{pv})	16 v
Input current of PV panel (I_{pv})	4.7 A
Modulation frequency (f_m)	50 Hz
Carrier frequency (f_c)	10 kHz
Inductors (L_1, L_2)	100mH, 100mH
Capacitors (C_1, C_2, C_0)	100 μ F, 100 μ F, 220 μ F
Resistances (R_{in}, R_{dc}, R_o)	100 Ω , 250 Ω , 50 Ω
Output Filter: Inductor (L_f)	4.6mH
Capacitor (C_f)	10 μ F
Coupled Inductor: Inductor (L_a)	1.78mH
Inductor (L_b)	1.78mH
Turns ratio (n)	1

The Fig. 6. shows the Output AC voltage and current of the propounded Inverter. Fig. 7. and Fig. 8. shows the Input AC voltage and Output DC voltage (DC Link voltage) of the propounded Inverter. The obtained DC voltage is about 348 v.

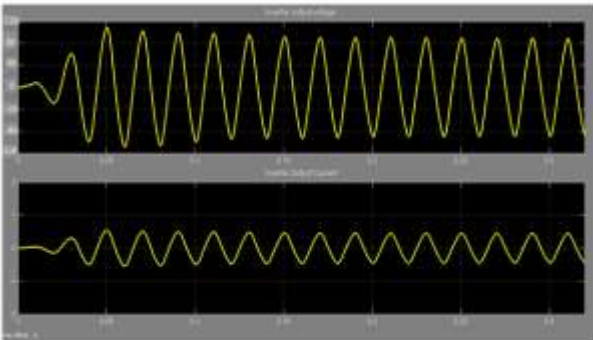

Fig. 6. Simulation of AC Output Voltage and Current

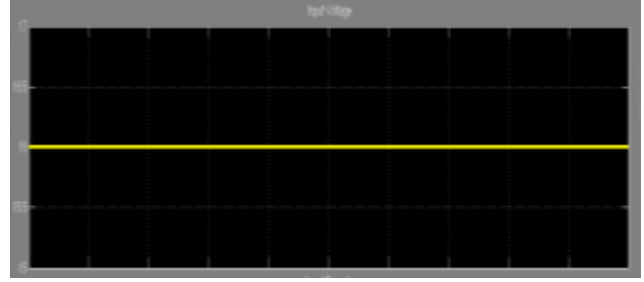

Fig. 7. Simulation of DC Input Voltage

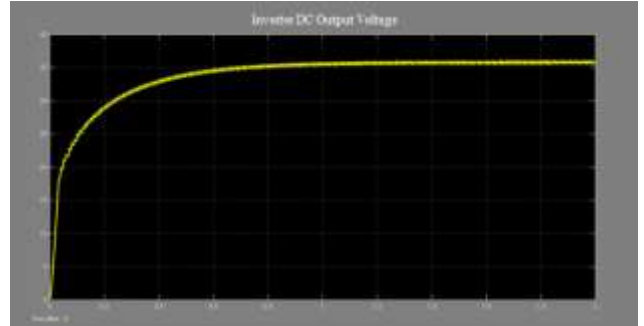

Fig. 8. Simulation of DC Output Voltage

Sine Pulse width Modulation (PWM) technique is utilized for controlling the switches. The PWM technique [13] for proposed CFSI is constructed from the conventional sine triangle PWM technique with unipolar voltage switching.

6. Experimental Results – Verification:

A paradigm is fabricated to analyze the proposed Coupled Inductor based CFSI topology. Fig. 9. shows the photograph of the test bed Hardware prototype. FPGA, SPARTAN 6-LXA has been implemented in the system for PWM control of the Inverter. The Fig. 10. shows the AC output voltage of Proposed CFSI. The Fig. 11. and Fig. 12. shows the Input and Output DC voltage. The Fig. 13. and Fig. 14. shows the gate pulses given to the Inverter switches (S1, S3 and S2, S4).



Fig. 9. Hardware Prototype of Proposed CFSI

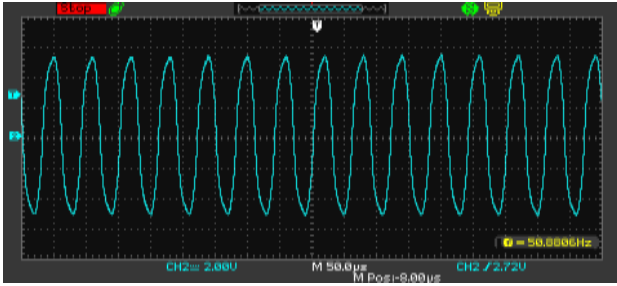

Fig. 10. Hardware output AC voltage of Proposed CFSI

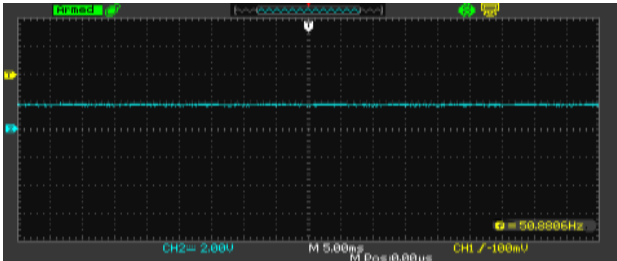

Fig. 11. Hardware Input DC voltage of Proposed CFSI

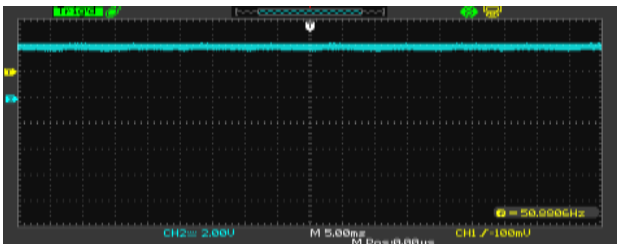

Fig. 12. Hardware output DC voltage of Proposed CFSI

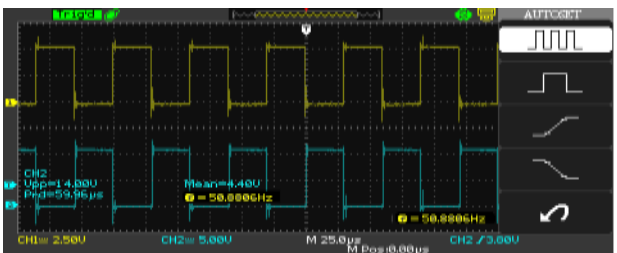

Fig. 13. Gate pulses given to Inverter Switches (S1,S3) of Proposed CFSI

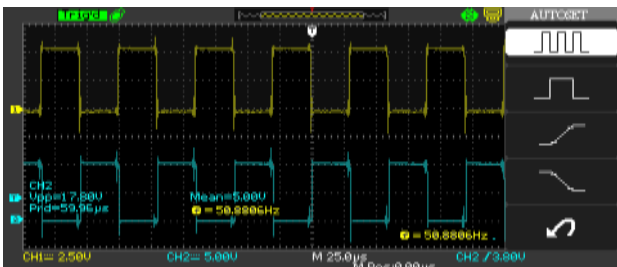

Fig. 14. Gate pulses given to Inverter Switches (S2,S4) of Proposed CFSI

The design specifications of the Hardware prototype are same as Simulation parameters as indexed in Table I and it also includes the MOSFET Switches (S1,S2,S3,S4) with specification IRF 630.

7. Conclusion:

The propounded CFSI is a Single-stage High-Boost Inverter which consists of Coupled Inductor, which can be used for obtaining extended voltage gain. In this paper, the magnetic incorporation of all inductors reduces the converter volume and the gate pulse generation in this inverter is simple. The gain of this inverter is alike to that of ZSI and conventional CFSI. The proposed Inverter can overwhelm the boost restrictions of ZSIs due to increased component voltage stresses and deprived output power quality. This Inverter also possesses all the advantages of ZSI and SBI topology such as a flow of input current, lower voltage stress on capacitors, etc. The propounded Inverter is well suited for Renewable applications such as fuel cells and PV Systems, which requires a Single-Stage high step-up boost inversion of reduced DC voltage sources. A detailed theoretical study of the propounded Inverter was discussed briefly and the performance through Experimental results and Simulations were verified.

References

1. Byun, J., Park, S., Kang, B., Hong, I., Park, S.: *Design and implementation of an intelligent energy saving system based on standby power reduction for a future zero-energy home environment*. In: IEEE Transactions on Consumer Electronics (2013), Vol. 59, No. 3, October 2013, pp. 507–514.
2. Peng, F. Z.: *Z-source Inverter*. In: IEEE Transactions on Industrial Applications (2003), Vol. 39, No. 2, March/April 2003, pp. 504–510.
3. Kerekes, T., Liserre, M., Teodorescu, R., Klumpner, C. and Sumner, M.: *Evaluation of three-phase transformerless photovoltaic inverter topologies*. In: IEEE Transactions on Power Electronics (2009), Vol. 24, No. 9, September 2009, pp. 2202–2211.
4. Gonzalez, R., Gubia, E., Lopez, J., Marroyo, L.: *Transformerless single-phase multilevel-based photovoltaic inverter*. In: IEEE Transactions on Industrial Electronics (2008), Vol. 55, No. 7, July 2008, pp. 2694–2702.

5. Carrasco, J. M., Franquelo, L. G., Bialasiewicz, J. T., Galvan, E., Guisado, R. C. P., Prats, M. A. M., Leon, and N. Moreno-Alfonso J. I.: *Power electronic systems for the grid integration of renewable energy sources: A survey*. In: IEEE Transactions on Industrial Electronics (2006), Vol. 53, No. 4, June 2006, pp. 1002–1016.
6. Anderson, J., Peng, F.z.: *Four Quasi-Z Source Inverters*. In: IEEE Power Electronics Specialists Conference, PESC 2008, pp. 2743 - 2749.
7. Mishra, S., Adda, R., Joshi, A.: *Inverse Watkins-Johnson Topology-Based Inverter*. In: IEEE Transactions on Power Electronics (2012), Vol. 27, No. 3, 2012, pp. 1066 - 1070.
8. Adda, R., Ray, O., Mishra, S., Joshi, A.: *Synchronous Reference Frame Based Control of Switched Boost Inverter for Standalone DC Nanogrid Applications*. In: IEEE Transactions on Power Electronics (2013), Vol. 28, No. 3, 2013, pp. 1219 – 1233.
9. Ravindranath, A., Mishra, S., Joshi, A.: *Analysis and PWM Control of Switched Boost Inverter*. In: IEEE Transactions on Industrial Electronics (2013), Vol. 60, No. 12, December 2013, pp. 5593-5602.
10. Wei Qian, Peng, F.Z., Cha, H.: *Trans-Z Source Inverters*. In: IEEE Transactions on Power Electronics (2011), Vol. 26, No. 12, 2011, pp. 3453 - 3463.
11. Soumya Shubhra Nag, Santanu Mishra: *Current fed Switched Inverter*. In: IEEE Transactions on Industrial Electronics (2014), Vol. 61, No. 9, September 2014.
12. Soumya Shubhra Nag, Ravindranath Adda, Olive Ray, Santanu Mishra: *Current-Fed Switched Inverter Based Hybrid Topology for DC Nanogrid Application*. In 39th Annual Conference of IEEE Industrial Electronics Society, IECON, 2013, pp.7146-7151.
13. Adda, R., Ray, O., Mishra, S., Joshi, A.: *DSP based PWM control of Switched Boost Inverter for DC nanogrid applications*. In: Proceedings of the 38th Annual Conference of IEEE Industrial Electronics Society, IECON, 2012 , pp. 5285 – 5290.
14. Yang, S., Peng, F. Z., Lei, Q., Inoshita, R., Qian, Z.: *Current-fed quasi-z-source inverter with voltage buck-boost and regeneration capability*. In: IEEE Transactions on Industrial Electronics (2011), Vol. 47, No. 2, March/April 2011, pp. 882–892.
15. Qian, W., Peng, F. Z., Cha, H.: *Trans-Z-source inverters*. In: IEEE Transactions on Power Electronics (2011), Vol. 26, No. 12, December 2011, pp. 3453–3463.
16. Y. Tang, S. Xie, and C. Zhang: *Single-phase Z-Source inverter*. In: IEEE Transactions on Power Electronics (2011), Vol. 26, No. 12, December 2011, pp. 3869–3873.
17. Cao, D., Jiang, S., Yu, X., Peng, F. Z.: *Low-cost semi-Z-source inverter for single-phase photovoltaic systems*. In: IEEE Transactions on Power Electronics (2011), Vol. 26, No. 12, December 2011, pp. 3514–3523.
18. Rico, M., Uceda, J., Sebastian, J., Aldana, F. : *Static and dynamics modeling of tapped-inductor DC-to-DC converters*. In: Proceedings of IEEE PESC, 1987, pp. 281–288.
19. Witulski, A. F.: *Introduction to modeling of transformers and coupled inductors*. In: IEEE Transactions on Power Electronics (1995), Vol. 10, No. 3, May 1995, pp. 349–357.
20. Ahmed, F., Cha, H., Kim, S., Kim, H.: *Switched-Coupled-Inductor Quasi-Z-Source Inverter*. In: IEEE Transactions on Power Electronics (2016), Vol. 31, No. 2, February 2016 , pp. 1241–1254.
21. Huang, L., Zhang, M., Hang, L., Yao, W., Lu, Z.: *A Family of Three-Switch Three-State Single-Phase Z-Source Inverters*. In: IEEE Transactions on Power Electronics (2013), Vol. 28, No. 5, May 2013, pp. 2317–2329.
22. Shen, M., Peng, F. Z., Tolbert. L. M.: *Multilevel DC-DC power conversion system with multiple DC sources*. In: IEEE Transactions on Power Electronics (2008), Vol. 23, No. 1, January 2008, pp. 420–426.