

THREE ZONE QUADRILATERAL ADAPTIVE DISTANCE RELAY FOR THE PROTECTION OF PARALLEL TRANSMISSION LINE WITH MUTUAL COUPLING

S.G.SRIVANI and K.P.VITTAL

National Institute of Technology, Surathkal, Karnataka, India

Ph.0824-2474000. Fax 0824-2474033, Email.-srivani_9@hotmail.com,vittal_nitk@yahoo.mail

Abstract: This paper describes the development and evaluation of an adaptive distance relaying scheme for the protection of parallel transmission line having mutual coupling effect. The quadrilateral trip characteristic with directionality feature is developed for three zone protection. The relay adapts setting for the correct operation based on the availability of the input signals. Zero sequence current, if available from the parallel transmission line, is used to fully compensate the mutual coupling effect. When the parallel line's zero sequence current is not available, the line operating status is used to select the proper zero sequence current compensation factor in impedance calculation. If both the signals mentioned above are not available, default compensation factor is used. The performance of the proposed adaptive relaying is tested extensively for the fault transients obtained by simulating a realistic power system in PSCAD and sample results are presented.

Key words Adaptive relaying, coupled transmission lines, distance protection, mutual coupling, quadrilateral trip characteristic, zones of protection.

1. Introduction

Parallel transmission lines have been extensively utilized in modern power system to enhance the reliability and security for the transmission of electrical energy. The different possible configuration of parallel lines combined with the effect of mutual coupling make their protection a challenging problem. Commonly the transmission line protection systems have been designed with distance protection. However, Distance protection, suffers from inaccuracy. This inaccuracy is caused for a great deal by parallel lines. Mutual coupling can cause incorrect tripping of distance relays. In particular, overreach can cause sympathy trips, which can lead to major power system disturbances. They should whenever possible be avoided and it is therefore important to make the relays as accurate as possible. We find some proposed solutions in [1]-[3]. The adaptive scheme proposed in [1] where impedance calculation is done using a correction factor, based on the information of the surrounding system of the protected line under

different operating status. In [2], an adaptive distance protection scheme proposed which accesses multiple locally available signals and automatically adapts its operation to the signal availability. In [3] a travelling-wave based parallel line protection scheme was investigated.

In this paper, development and Evaluation of three-zone quadrilateral adaptive distance relay is presented. In order to minimize the required communication, local measurements are used to estimate the entire power system condition. The proposed adaptive distance protection scheme accesses multiple locally available signals and automatically adapts its operation to the signal availability. The scheme uses the best available signals for optimal performance at all the moments. The quadrilateral trip characteristic with directionality feature is developed for three-zone protection. The performance evaluation of developed adaptive distance relay is done extensively under different faults and power system conditions by simulating a realistic parallel line transmission system in PSCAD.

The comparative analysis is made extensively with that of conventional distance relay and the results are tabulated and graphs are shown. The test results evaluation proves the efficacy of the adaptive distance relay over the conventional distance relay.

2. Distance protection of a double-circuit line with mutual coupling

When there is a single phase-*a* -to-ground fault on a single line, the measured phase impedance seen by the conventional distance relay by using conventional zero sequence current compensation method with fault impedance zero is given as

$$Z_{m-a} = \frac{V_a}{I_a + K_0 I_0} = mZ_{1L} \quad (1)$$

$$K_0 = \frac{Z_{0L} - Z_{1L}}{Z_{1L}} \quad (2)$$

where,

K_0 : The line zero sequence current compensation factor;

Z_{0L} and Z_{1L} : The zero and positive sequence impedance of the line.

V_a and I_a : The post-fault phase voltage and current at the relay location,

m : The per-unit distance between the relay and the fault location

I_0 : The post-fault zero sequence current at the relay location.

Generally, the mutual coupling effects between parallel lines caused by positive and negative sequence currents are very small and are considered to be negligible. However, the mutual coupling effects of zero sequence currents between parallel lines could be significant [2].

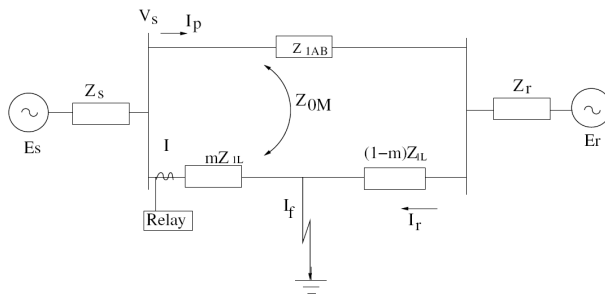

Fig. 1. Parallel Transmission Line

Fig.1 illustrates the conventional distance as applied to protect the parallel lines with mutual coupling. The post-fault voltage of phase at the relay location for a phase-a-to-ground fault when fault impedance is zero is given by

$$V_a = m Z_{1L} (I_a + K_0 I_0 + m Z_{0M} I_{0p}) \quad (3)$$

Where, Z_{0M} is the total zero sequence mutual coupling line impedance and I_{0p} is the parallel lines zero sequence current. The measured fault impedance of a distance relay using conventional zero sequence current compensation will contain errors since

$$Z_{1m-a} = \frac{V_a}{I_a + K_0 I_0} = m Z_{1L} + \zeta Z_{1L} \quad (4)$$

Where, the per unit error ζ in terms of Z_{1L} is

$$\zeta = \frac{m(Z_{0M} / Z_{1L}) I_{0p}}{I_a + K_0 I_0} \quad (5)$$

This error may cause the relay either to overreach or underreach depending upon the relative direction of the

parallel line's zero sequence current, I_{0p} , versus the compensated current, $I_a + K_0 I_0$. If they are in the opposite direction, the relay will overreach. If in the same direction, the relay will underreach.

The above overreach or underreach effect of conventional distance relays, caused by the mutual coupling may be compensated by selecting proper relay settings provided the bus configuration, system impedance and line operating condition of a parallel line do not change during the normal operation.

Due to various reasons like load dispatch, forced Outage, scheduled maintenance etc, operating condition of a parallel line could change from one to the other during the normal operations.

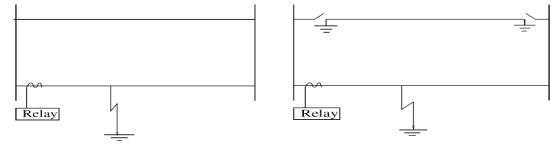

Fig. 2. Parallel-Line typical Operating Modes. (a). Both Lines are in Operation. (b). One Line switched off and Grounded at Both the Ends.

Fig. 1 and 2 show such two typical operating conditions of a double-circuit line.

Generally, the line operating condition shown in Fig. 2(a) will cause conventional distance relay to underreach and the line operating condition shown in Fig. 2(b) will cause conventional distance relay to overreach for remote end faults [2] Also the other line operating conditions and/or the bus configurations combinations may further complicate the problem.

Parameters and functions of relays are normally set only when the relay is installed. Generally in parallel line distance protection the settings are chosen such that they can cover the worst-case situation [2,3,4]. Even though the Safety margins are used to ensure correct operation in as many situations as possible, the result of this method is that the relays operate incorrect or delayed. Sympathy trips due to unexpected the wide range of power system condition thus increasing the accuracy and selectivity of the protection system

3. Development of proposed Adaptive Distance Relay

The adaptive scheme for the proposed relay on each protected line accesses the three-phase voltage and current signals of the protected line. In addition, the zero sequence current and line operating status of the paralleled lines at the substation where the distance relay is located will be used by the scheme. The parallel line's zero sequence current could be obtained

either through additional cabling, direct communication link between relays, or substation local networks. The parallel line's operating status could be obtained by accessing the circuit breaker's auxiliary contacts and/or parallel line's voltage/current level detection or substation PLC (programmable logic controller). The scheme automatically adapts its operation based on the signal availability from the parallel lines to achieve an optimal performance by using the best available signals. Figure.3 illustrates the adaptive scheme [2] implemented in the proposed new relay.

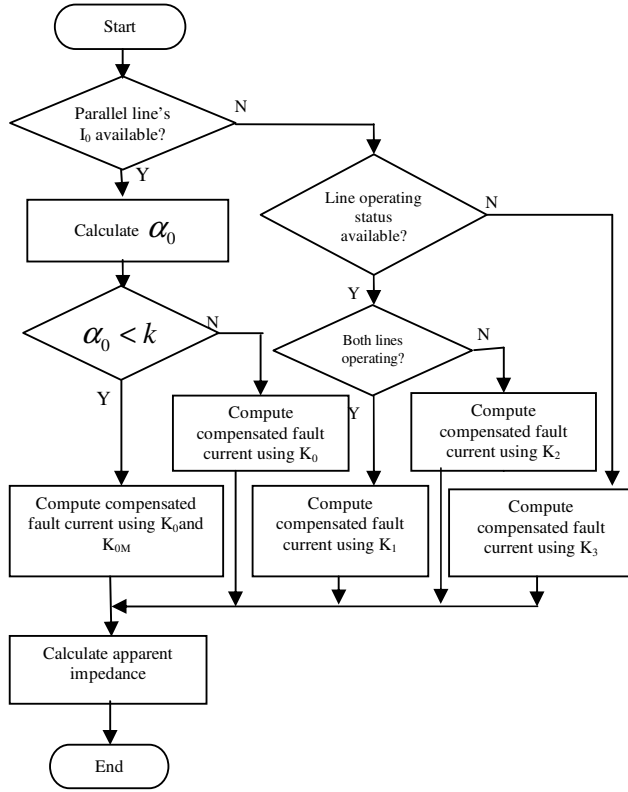

Fig. 3. Flowchart for Adaptive Distance Protection Scheme.

If the parallel line's zero sequence current is available the scheme uses it first to compensate the mutual coupling effect in impedance measurement on faulted line. For a phase-a -to-ground fault on the protected line, the correct fault impedance on the faulted line is given by (6)

$$Z_{m-a} = \frac{V_a}{I_a + K_0 I_0 + k_{0M} I_{0p}} = m Z_{1L} \quad (6)$$

Where

$$K_{0M} = \frac{Z_{0M}}{Z_{1L}} \quad (7)$$

Thus the error in distance measurement caused by the mutual coupling effect of I_{0p} is fully compensated.

When Parallel line's zero sequence current compensation is applied on both faulted line and healthy line in the impedance computation, the relay placed in healthy line will also operate with the relay placed in faulted line.

To avoid such possible false operation, the compensation should be adapted to the line fault status. In the proposed scheme it is achieved by using a zero sequence current ratio criterion, defined as a magnitude ratio of paralleled line's zero sequence current over the zero sequence current measured on the protected line [2].

$$\alpha_0 = \frac{|I_{0p}|}{|I_0|} \quad (8)$$

By setting a proper threshold selected, so that the relay false operation on the healthy line for close-in faults on an adjacent parallel line could be effectively prevented. when the parallel line's zero sequence current is not available due to local technical problems to the relay for various reasons[2], the proposed adaptive scheme adopts to use parallel line's operating status signal, for an improved performance. A relay could make proper zone setting and/or zero sequence compensation as in Figure 2(a).

In Figure 4, $Z_{AB0} = Z_{L0}$ is assumed, the accurate zero sequence compensation factor in (1) at m the fault location under this condition is,

$$K_1(m) = K_0 \left(1 + \frac{Z_{0M}}{Z_{0L} - Z_{1L}} \cdot \frac{m Z_{0R} - (1-m) Z_{0S}}{(2-m) Z_{R0} + (1-m)(Z_{0S} + Z_{0L} + Z_{0M})} \right) \quad (9)$$

which is a function of the fault location, system, and line impedance. Similarly, the zero sequence current Compensation factor for one parallel line switched off and grounded at both ends could be derived.

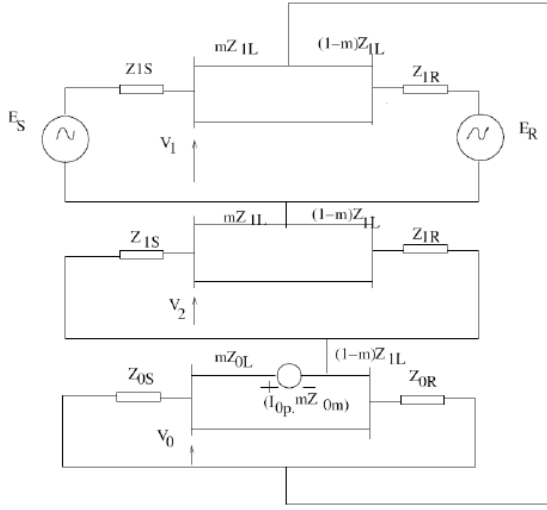

Fig.4. sequence network for both the lines in operation condition in a single line to ground fault.

The zero sequence network [2] for one parallel line switched off and grounded at both ends is shown in Fig. 5. If $Z_{0L} = Z_{0AB}$ is assumed, the accurate zero sequence compensation factor in (1) at the fault location m under this condition is

$$K_2(m) = K_0 \left\{ 1 + \frac{Z_{0M}}{Z_{0L} - Z_{0L}} \cdot \frac{Z_{0M}[(1-m)Z_{0S} - mZ_{0R}]}{Z_{0L}[(1-m)Z_{0L} + Z_{0R}] - (1-m)Z_{0M}^2} \right\} \quad (10)$$

which is also a function of the fault location, system, and line impedance on factor adjustment to take into account the mutual coupling effect corresponding to each line operating status. The value for zone 1 should also be determined at the zone setting boundary (80%) using (9) and (10) for more accurate compensation of system parameter variations, plus certain margins to avoid overreach operations.

In the case that both parallel line's zero sequence current and line operating status signals are not accessible, a default zero sequence compensation factor (K_3), based on the worst-case scenario, will be used by the new adaptive relay to ensure a reliable operation of the relay. This operation mode achieves the same performance level.

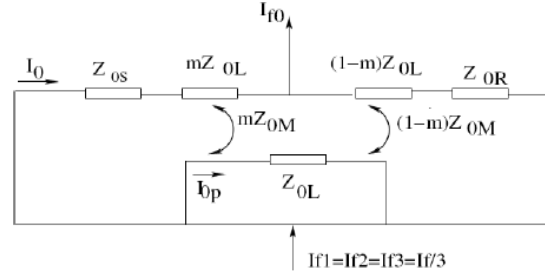
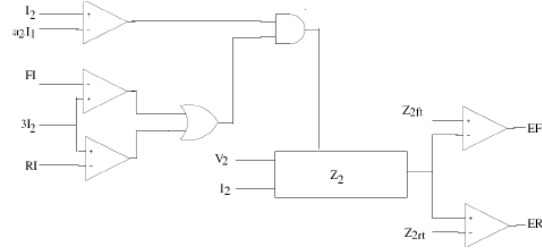

Fig.5. Zero Sequence network Connection for One Line Switched Off and Grounded Condition in a single line to ground Fault.

Fig. 6. Relay logic scheme of Directional Element.



4 Development and evaluation of three zone Quadrilateral characteristic with directionality feature

In the proposed adaptive relay negative sequence polarized directional element is considered as it has its own advantages for mutually coupled circuits. Fig. 6 shows the simplified block diagram of the relay logic scheme for negative-sequence voltage polarized directional element[5,6].

The negative sequence impedance is

$$Z_2 = \frac{\text{Re} [V_2 (1 \angle \theta_{L2} \cdot I_2)]}{|I_2|^2} \quad (11)$$

where, θ_2 : Line negative-sequence impedance angle.

V_2 : negative-sequence voltage,

I_2 : negative-sequence current,

The directional element Enable bit, asserts when all of the following conditions are true:

$$I_2 > a_2 I_1,$$

Where, I_1 is positive sequence current,

$$a_2 = \frac{\min I_2}{I_1}, \text{ generally this factor varies between } 0.07-0.1.$$

$3I_2$ is greater than forward and reverse negative-sequence current threshold (FI&RI).

This setting is above normal load unbalance and below

the lowest expected negative-sequence current magnitude for unbalanced faults.

Forward threshold impedance, Z_{2FT} can be set for $\frac{1}{2}$ the positive sequence impedance of the line and Reverse threshold impedance, Z_{2RT} can be set equal to $Z_{2FT} + 1$ ohm. Any measured negative sequence impedance which is less than the Z_{2FT} setting is declared as a forward fault and any measured negative sequence impedance which is more than Z_{2RT} is considered a reverse fault.

The flowchart of Fig. 8 depicts the development of three zone quadrilateral trip characteristic with directionality feature. Fig 9 shows the relay trip logic for zone1. The logic is developed for three zone distance protection. Zone1 and zone2 covers 80% and 120% of the line respectively from relay location in forward direction.

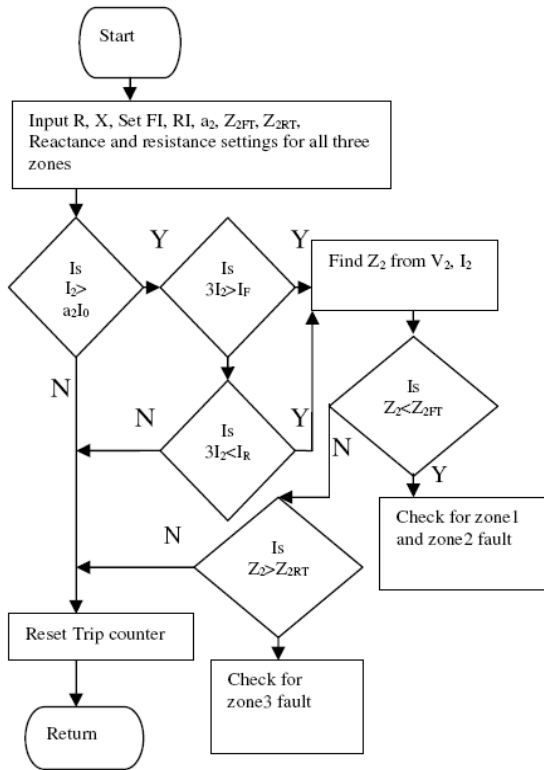

Fig 7 Flowchart for Determining the Directionality of three zone quadrilateral relay.

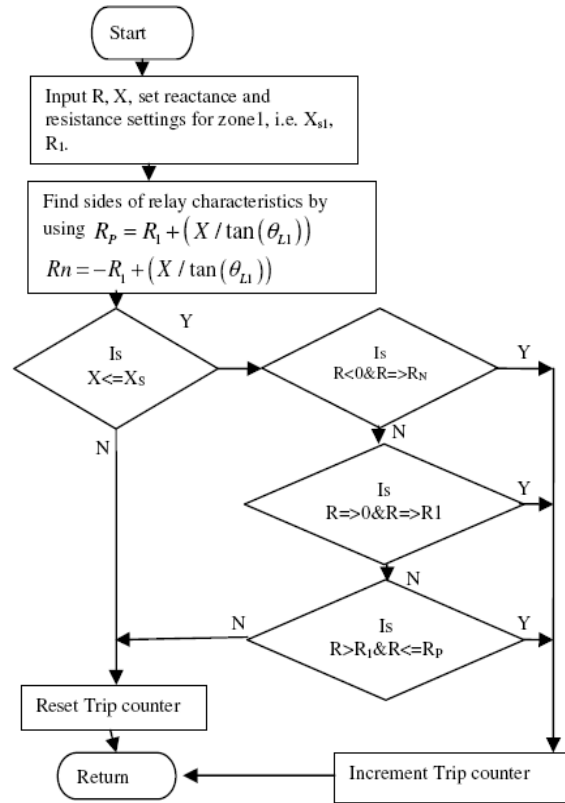
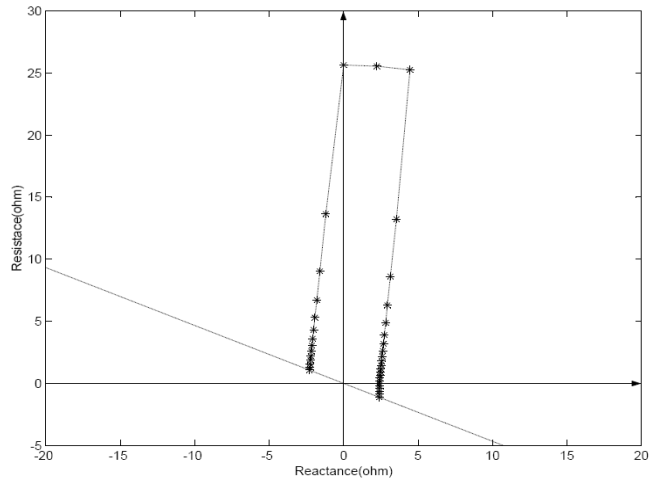

Fig 9 Quadrilateral Relay Logic for Zone1



The Fig 10 shows the developed quadrilateral characteristic with the reactance and resistance reach settings as $X=24.7 \Omega$ $R=2.4 \Omega$.

Fig 8 Quadrilateral trip characteristic by steady state test

The dynamic tests essentially determine the operating time and reach settings of the relay, when subjected to various fault conditions. This requires the

simulation of transient fault dynamic conditions of the power transmission line. For this purpose, EMTDC/PSCAD software package is used. The parallel transmission system considered is a 400KV, 200km long Transmission system as shown in Fig. 9.

Fig.9. Single Line Diagram of Parallel Transmission System.

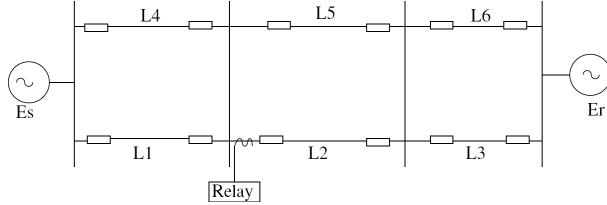

The lengths of the line are: L1, L4 =80 km; L2, L5 = 80 km;L3, L6 = 40 km. The system parameters are as follows

Line Impedance:

$$Z_{L0} = 0.297 + 1.1842i \ \Omega / km$$

$$Z_{L1} = Z_{L2} = 0.0352 + 0.4028i \ \Omega / km$$

$$Z_{0m} = 0.262 + 0.7814i \ \Omega / km$$

Equivalent System Impedance:

$$Z_{S0} = 23.459 + 108.31i \ \Omega$$

$$Z_{S1} = 8.561 + 20.241i \ \Omega$$

$$Z_{R0} = 17.53 + 70.795i \ \Omega$$

$$Z_{R1} = 8.36 + 15.57i \ \Omega$$

In this development frequency dependent (Phase) model is selected in EMTDC/PSCAD for transmission line model. The adaptive relay is developed for three zone protection. Zone1 covers the 80% of the line 2, zone 2 covers 120% of the line 2, and zone 3 covers 20% of the line 1 in reverse direction (20% of line 1 before relay location). The quadrilateral trip characteristic will change automatically obtaining the parallel line's operating status through substation PLC. In order to conduct the evaluation test, two configurations of parallel transmission line are considered, they are

1. One Line is Switched Off and grounded at Both Sides,
2. Two Parallel Lines are in Operation.

The test signals are obtained under various fault locations for the above configurations using PSCAD. They are

- ✓ 10% inside the zone1
- ✓ 10% outside the zone2
- ✓ 10% before the relay location.

The developed adaptive relay is tested for all types of

ground faults for the above mentioned conditions and results are presented in tables. Finally the adaptive relay performance is compared with the performance of the conventional relay for different cases.

1) One Line is Switched off and grounded at Both Sides

Fig. 10 shows the configuration of one line is switched off and grounded at both sides

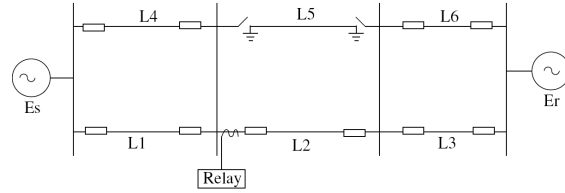

Fig. 10 Parallel line circuits with one line switched off and grounded at both ends.

The Table 1 shows the performance of the developed adaptive relay for different fault conditions considered under the above circuit configuration. The different fault conditions are given case reference numbers which are shown in table inside brackets. In subsequent discussion these case numbers are used for referring to each case.

2) Two Parallel Lines are in Operation

Table 2 illustrates the results obtained when the zero sequence current of adjacent parallel line is available. Table 3 illustrates the results obtained when the zero sequence current of adjacent parallel line is not available.

Observing the operating times of Table 3 and Table 4, we can say that the operating time of the adaptive relay is almost same whether zero sequence current of adjacent parallel line is available or not. This gives the advantage of stable operation of the relay with adaptability.

The R-X Trajectories of adaptive relay in zone 1 and zone 2 are drawn and discussed in next section in comparison with conventional relay. The Fig. 11 shows the R-X trajectory when the fault occurred in reverse direction from the relay location (zone 3).

The evaluation tests were conducted on conventional distance relay in order to compare its performance with that of adaptive distance relay. The fault data sets that are used in evaluating the adaptive distance relay has been used for comparing the performance of the conventional distance relay. The Table 4 indicates the comparative performance of both the relays.

Table 1 One Line Switched Off and Grounded at Both Ends

Type of fault	Location of fault w.r. t.	Load applied	Inception of fault at voltage	Relay operating time(ms)
AG	10% inside the zone 1 end	10% FL	Zero(a.1)	27ms
			Peak(a.2)	33ms
		90% FL	Zero(a.3)	26ms
			Peak(a.4)	40ms
	10% outside the zone1 end	10% FL	Zero(a.5)	404ms
			Peak(a.6)	404ms
		90% FL	Zero(a.7)	404ms
			Peak(a.8)	404ms
10% before the relay location	10% FL	Zero(a.9)	503ms	
	90% FL	Zero(a.10)	503ms	
BCG	10% inside	10% FL	Zero(a.11)	30ms
	10% outside	90% FL	Peak(a.12)	404ms

Table 2. Two Lines are in Operation with the Availability of Parallel's Line Zero Sequence Current

Type of fault	Location of fault w.r. t.	Load applied	Inception of fault at voltage (Case no.)	Relay operating time(ms)
AG	10% inside the zone 1 end	10% FL	Zero(b.1)	25ms
			Peak(b.2)	28ms
		90% FL	Zero(b.3)	24ms
			Peak(b.4)	21ms
	10% outside the zone1 end	10% FL	Zero(b.5)	402ms
			Peak(b.6)	402ms
		90% FL	Zero(b.7)	402ms
			Peak(b.8)	402ms
	10% before the relay location	10% FL	Zero(b.9)	503ms
			Peak(b.10)	508ms
		90% FL	Zero(b.11)	503ms
			Peak(b.12)	508ms
BCG	10% inside	10% FL	Zero(b.13)	24ms
	10% outside	90% FL	Peak(b.14)	402ms

Table 3. Two Lines are in Operation with out the Availability of Parallel's Line Zero Sequence Current.

Type of fault	Location of fault w.r. t.	Load applied	Inception of fault at voltage	Relay operating time(ms)
AG	10% inside the zone 1 end	10% FL	Zero(c.1)	24ms
			Peak(c.2)	28ms
		90% FL	Zero(c.3)	24ms
			Peak(c.4)	21ms
	10% outside the zone1 end	10% FL	Zero(c.5)	402ms
			Peak(c.6)	402ms
		90% FL	Zero(c.7)	402ms
			Peak(c.8)	402ms

Table 4. Comparison between Adaptive and Conventional Distance Relay

Fault condition (fault location)	R-X plot (Fig)	Operating Time		Operating Status *mal operation ✓ Correct operation	
		Conv.Relay (Tripped in)	Adaptive Relay	Conv. Relay	Adaptive Relay
a.1 (Zone 1)	12	27ms, (Zone 1)	28ms	✓	✓
a.2 (Zone 1)	---	31ms, (Zone 1)	33ms	✓	✓
a.3 (Zone 1)	---	27ms, (Zone 1)	26ms	✓	✓
a.4 (Zone 1)	---	32ms, (Zone 1)	40ms	✓	✓
a.5 (Zone 2)	---	27ms, (Zone 1)	Zone 2	✗	✓
a.6 (Zone 2)	13	25ms, (Zone 1)	Zone 2	✗	✓
a.7 (Zone 2)	14	26ms, (Zone 1)	Zone 2	✗	✓
b.1 (Zone 1)	---	25ms	25ms	✓	✓
b.2 (Zone 1)	15	(Zone 2)	28ms	✗	✓
b.3 (Zone 1)	---	25ms	24ms	✓	✓
b.4 (Zone 1)	16	21ms	21ms	✓	✓
b.5 (Zone 2)	---	(Zone 2)	Zone 2	✓	✓
b.6 (Zone 2)	17	(Zone 2)	Zone 2	✓	✓

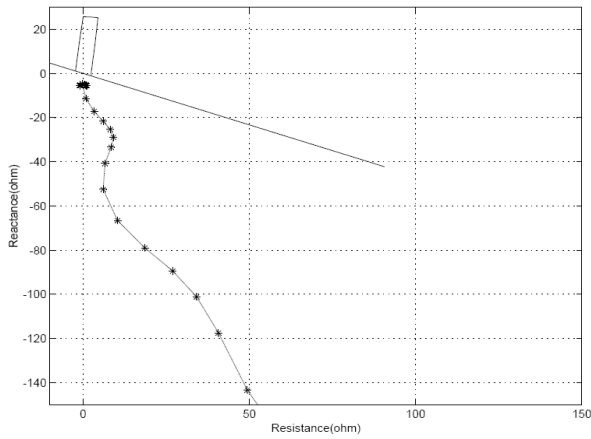

Fig.11 R-X Diagram for AG Fault (Zone3) with incident at voltage peak 90%FL.

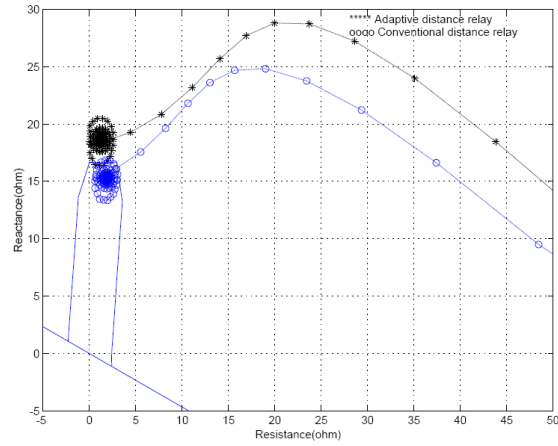

Fig. 14 R-X Diagrams of Adaptive and Conventional Relay (case a7)

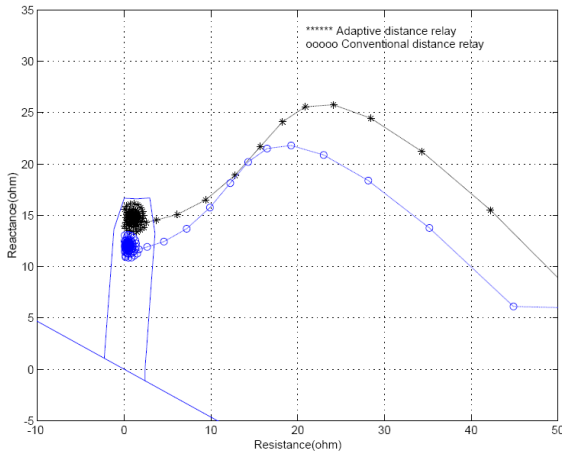

Fig.12 R-X Diagrams of Adaptive and Conventional Relay (case a.1)

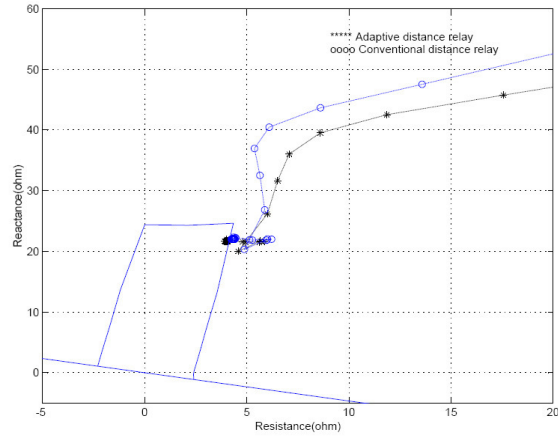

Fig.15 R-X Diagrams of Adaptive and Conventional Relay (case b.2)

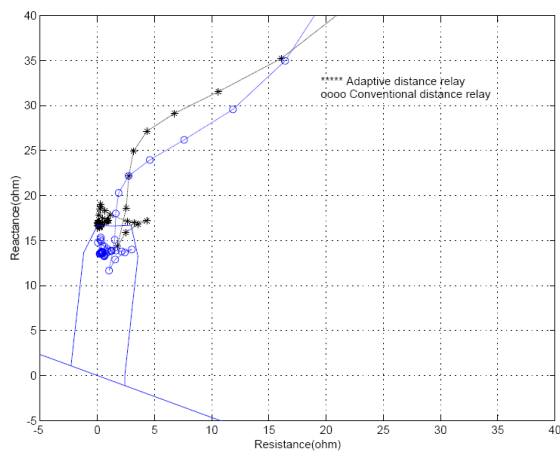

Fig.13 R-X Diagrams of Adaptive and Conventional Relay (case a6)

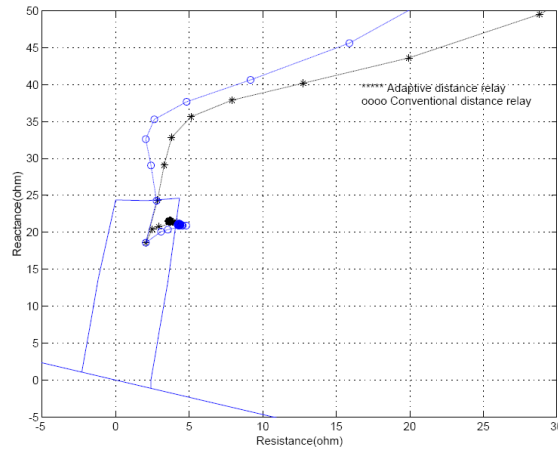

Fig. 16 R-X Diagrams of Adaptive and Conventional Relay (case b4)

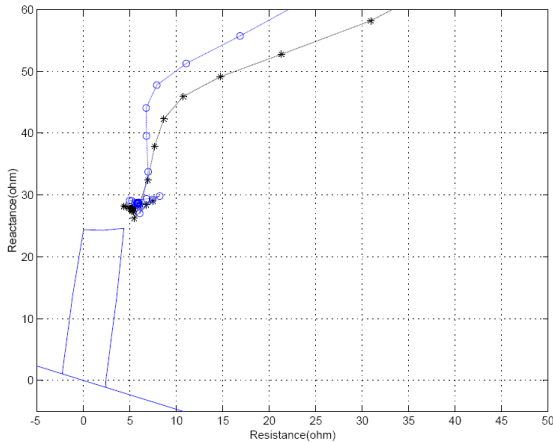

Fig. 17 R-X Diagrams of Adaptive and Conventional Relay (case b6)

The impedance trajectories of Fig.13 and Fig.14 for both adaptive relay and conventional relay show clearly that the conventional relay overreaches and on the other hand the proposed adaptive relay operated correctly. In some cases, for example in the cases (a.2) and (a.4), the operating time of the adaptive relay is more, but it is operating correctly compare to conventional relay. We can also observe when the two lines are in operation, the conventional distance relay of zone 1 mal operated in zone2 (case (b.2)). This can be found by observing the R-X plots of Fig 15. In some cases like case (b.4), where the trip count is fixed, even though the conventional relay operated but the impedance computed is erroneous, thus final impedance value lies outside the reach of the relay. Thus relay underreaches and the same can be observed in the R-X plot of Fig.16. The evaluation test results show the efficacy of adaptive distance relay over the conventional distance relay. In Fig.17 both the relays have operated correctly.

5. Conclusions and Future scope

The influence of the mutual coupling of parallel circuits on the accuracy of ground distance relays depends on the actual power system condition. Adaptive protection offers an approach to cope with the influence caused by the variable power system conditions. The adaptive distance relay described in this paper provides an enhanced distance protection for parallel lines. No remote signals (adjacent parallel line zero sequence current) are required for this scheme. This adaptive relay access the operating status of the parallel line through the substation PLC. The adaptation to the signal availability provides a built-in fallback scheme, which ensures the reliable operation under all conditions. The developed quadrilateral trip

characteristic with directionality feature is tested for the three zone protection. Application of the proposed adaptive distance relay would provide an enhanced performance for distance protection on parallel lines with mutual coupling.

The work could be further extended to increase the speed and accuracy of the relay proposed, considering new adaptive relaying algorithms. Further the scheme can be extended to parallel lines with series compensation to have an integrated protection scheme.

References

1. A.G.Jongepier, L.van der Sluis, "Adaptive Distance Protection of a Double-Circuit Line", IEEE Transactions on Power Delivery, Vol.9, pp.1289-1297, July 1994.
2. Yi Hu, Damir Novosel, Murali Mohan saha, "An Adaptive Scheme for Parallel-Line Distance Protection", IEEE Transactions on Power Delivery, Vol.17, pp. 105-110, Jan2002.
3. M .H. J. Bollen, "Traveling-wave-based protection of double-circuit lines," Proc. Inst. Elect. Eng., pt. C, vol. 140, no. 1, pp. 37-47, Jan.1993.
4. P. G. McLaren, I. Fernando, H. Liu, E. Dirks, G.W. Swift, and C. Steele, "Enhanced double circuit line protection," IEEE Trans. Power Delivery, vol. 12, pp. 1100-1108, July 1997
5. R.D. Dunlop, R.Gutman, P.P.Marchenko, "Analytical Development of Laudability Characteristics for EHV and UHV Transmission lines", IEEE Transactions on Power Apparatus and Systems, Vol.PAS-98, pp. 606-617, April 1979.
6. Jeff Roberts, Steve Turner, "Setting the Zero-Sequence Compensation Factors in SEL-321 Relays to Avoid Overreach in Mutual Coupling Lines", *Application guidelines*, Schweitzer Engineering Laboratories, Washington, USA. <http://www.selinc.com>.

S.G. Srivani received ME(PS) in 1990. She is presently working as Assistant professor in RV College of Engineering, Bangalore, India in the department of Electrical and Electronics Engineering. At this moment she is pursuing PhD research program at National Inst. of Technology, Karnataka – Surathkal, Mangalore, Her current research focuses on adaptive distance relaying schemes in power system protection.

K.P. Vittal received his PhD from Mangalore university in 1999. He is currently professor at the Department of Electrical and Electronics Engineering, National Institute of Technology Karnataka, Surathkal, India. His current research interest include power system protection, power quality and design of embedded systems .