

# A Fast Algorithm for Mode Switching of TCSC in Less Than a Half Cycle

M. NAYERIPOUR M.MANSOURI

Shiraz University of Technology, Shiraz, IRAN  
[Nayeripour@sutech.ac.ir](mailto:Nayeripour@sutech.ac.ir), [mansuri5m@yahoo.com](mailto:mansuri5m@yahoo.com)

**Abstract:** Fast mode switching from capacitive to inductive and vice versa has very important rule in transient stability and fault clearance critical time reduction but it has been considered rarely. Thyristor Controlled Series Capacitor (TCSC) as series compensator of transmission lines in capacitive mode has important rule in increasing loadability, loss reduction and stability improvement of the power systems. TCSC can be also used in inductive mode for increasing impedance of transmission line and fault current reduction. Unfortunately, TCSC is usually used in capacitive mode only. In this paper, a new and fast algorithm is proposed for mode switching of TCSC from capacitive to inductive and vice versa that it changes operation mode of TCSC in less than half cycle. The simulation results show that this method has more speed than conventional methods which they have more than three half cycle delay. The proposed method is very effective in improving of stability, special in transient stability, increasing time response of TCSC and fault current reduction.

**Key words:** Flexible AC Transmission Systems (FACTS), Thyristor Controlled Series Capacitor (TCSC), Mode Switching.

## 1. Introduction

The main goal of using Flexible AC Transmission Systems (FACTS) devices is compensating, increasing of speed response and stability improvements of a power system. TCSC as an important device of FACTS family has many capabilities like impedance decreasing or increasing, transmission line capacity increasing, transient and dynamic stability improving in the power systems [1].

Usually TCSC is used for dynamic stability improvement in different references and many of them have used the average impedance or dependent source models for TCSC that is enough for dynamic stability studies [2-3] and some have used TCSC for transient stability improvement in the first swing [4].

TCSC can work in one of its four operating modes: Capacitive, Inductive, Blocking and Bypass mode with control of firing angle. The TCSC impedance will change continuously by firing angle in each capacitive and inductive mode. Because of inhibited area existence (resonance between TCSC elements), it is not possible continues changing of TCSC impedance from capacitive to inductive modes (shown in Fig.1) [1].

As transmission lines have inductive impedance, TCSC usually is used in capacitive mode for line compensation and control and it does not need to mode switching of TCSC from capacitive to inductive mode thereupon the mode switching is studied rarely [5]. Whereas mode switching from capacitive to inductive and vice versa can have important rule in transient and fast dynamic stability improvement. TCSC fast mode switching from capacitive to inductive mode will be beneficial for current limiting of a fault in transmission line and also from inductive to capacitive mode after fault clearance. This subject can be also useful in other dynamic states like power oscillation damping (POD) [4-7].

However, TCSC is controlled by firing pulses but TCSC control has not studied in less than a cycle as thyristor switching view. TCSC mode switching was not used for POD in lectures for example [5] and the capacitive mode has used only whereas inductive mode of TCSC can have good effect in POD. In first survey, it seems that it is not possible to controlling TCSC in less than one cycle. The inductive mode operation of TCSC has laid away in researches from the first [7]. As current variations of transmission line in distortions are faster than the power system period, mode switching of TCSC in order of a cycle can restrict and control the distortions faster. This subject is analyzed only in [8] until now. [8] is proposed a method for mode switching of TCSC that has more than two half cycle (one cycle) delay. In [8], the firing command has not been applied to thyristors in a half cycle for mode switching from capacitive to inductive and a half cycle of inherent delay of TCSC. Therefore its method has one cycle delay at least.

In [9], a method is proposed on synchronizing of the firing pulses with ac source. This method will not have good operation in transient situations and it has not any propose to TCSC mode switching.

In this paper, a new and novel algorithm is proposed for mode switching of TCSC in less than a half cycle. Besides if zero crossing of line current occurs sooner or later in on distortions, the proposed method will change the TCSC mode fast to improving the transient stability but algorithms of [8] and [9] have not this capability and lose their operation modes.

## 2.Detail Analyses of TCSC Capacitive and Inductive Modes

TCSC consists of a series capacitor and Thyristor Controlled Reactor (TCR) as shown in Fig. 1. This set puts in series with the transmission line.

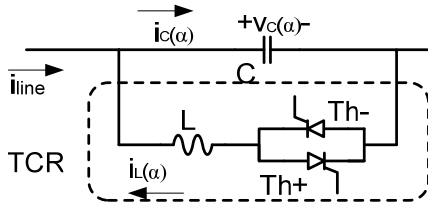

Fig. 1. Configuration of a TCSC

The TCSC impedance consists of the series capacitor and its parallel inductance impedance as Equation (1) [1].

$$jX_{TCSC}(\alpha) = \frac{jX_L(\alpha) * (-jX_C)}{jX_L(\alpha) + (-jX_C)}$$

Where  $jX_L(\alpha)$  is impedance of TCR branch and depends on firing angle ( $\alpha$ ) of thyristors. Base on this angle, one of the four Blocking, Bypass, Capacitive and inductive modes occurs.

### Blocking Mode

If thyristors be OFF always, the TCSC impedance consists of only the capacitor impedance  $X_C$ . This mode is named Blocking. It is obvious that TCSC behaves as series capacitor. The conducting angle is zero and firing angle is 90 degree related to zero crossing of the transmission line current in this mode [1].

### Bypass Mode

Bypass is another mode of TCSC operation modes and happens when both thyristors conduct 180 degree consecutive when they have right condition of conducting. The TCR branch is in circuit completely in this mode. The TCSC impedance is: [5]

$$jX_{TCSC} = \frac{jX_L(-jX_C)}{jX_L - jX_C} = -j \frac{X_L X_C}{X_L - X_C}$$

In Equation (2), negative  $X_{TCSC}$  means the overall impedance is capacitive and positive  $X_{TCSC}$  means the overall inductive impedance. As  $X_L$  is smaller than  $X_C$ , the TCSC impedance is inductive in bypass mode. Thyristors will be turned on in zero degree related to zero crossing of the line current.

### Capacitive and Inductive Mode

If firing angle is between zero and 90 degree, the impedance of TCR branch will be [1]:

$$X_L(\alpha) = X_L \frac{\pi}{\pi - 2\alpha - \sin 2\alpha}, X_L \leq X_L(\alpha) \leq \infty$$

Where  $\alpha$  is delay angle of thyristors turning on from zero crossing of line current and  $\sigma$  in conducting angle as  $\sigma = 2\pi - \alpha$ .

According to Equation (1) and (3) there is a resonance angle that  $X_L(\alpha_{resonance})$  will be equal to  $X_C$  and

Equation (1) will be infinite as shown in Fig.2. TCSC will be in capacitive mode for the firing angle greater than  $\alpha_{resonance}$  and will be in inductive mode for the firing angle smaller than this angle.

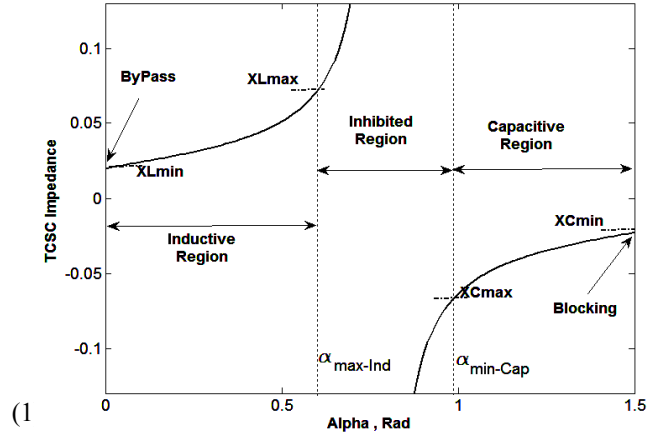

Fig. 2. TCSC mode operations

Because of resonance in  $\alpha_{resonance}$ , impedance changing of TCSC is high around this angle and it is very sensitive to firing angle deviations. Therefore an inhibited area always defines between capacitive and inductive region as shown in Fig.2 that it is defined by  $\alpha_{min\_Cap}$  and  $\alpha_{max\_Ind}$  boundary.

### Precision analyze of capacitive mode

The firing angle of TCR is assigned as  $X_L(\alpha) > X_C$  for TCSC operation in capacitive mode. This situation will happen in angles greater than  $\alpha_{min\_Cap}$  and smaller than 90 degree.

According to Fig.3 in delay angle  $\alpha$ , after zero crossing of the line current, the proper thyristor (Th+) turns on in  $t_1$  when the line current and capacitor voltage are in opposite sign. Afterwards a resonance circuit forms from L and C that resonates half cycle. The ON thyristor turns off in  $t_2$ .

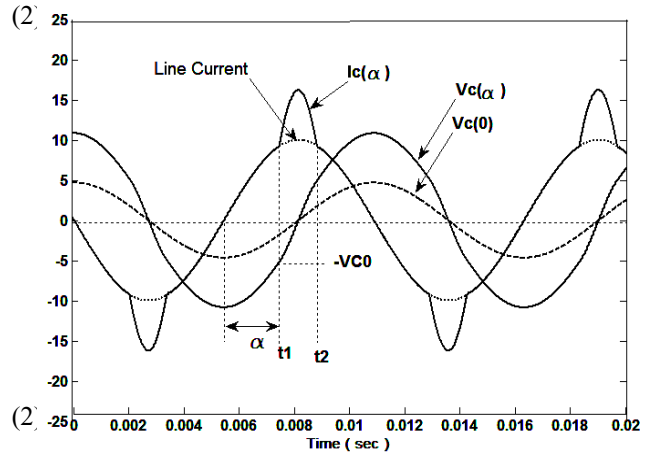

Fig. 3. Switching in capacitive mode and half cycle resonance of LC circuit

As shown in Fig.3, capacitor voltage inverting from  $-V_{C0}$  to  $+V_{C0}$  is result of half cycle resonance. The

capacitor voltage without switching is shown also in dash line in Fig.3. In real, the capacitor voltage increasing due to resonance circuit creates larger capacitive impedance for TCSC.

### Precision analyze of inductive mode

For TCSC operation in inductive mode, the firing angle of TCR branch must be so that  $XL(\alpha) < XC$ . This case happens when  $\alpha$  be greater than zero and smaller than  $\alpha_{max\_Ind}$ . As shown in Fig. 4, after delay angle  $\alpha$  from zero crossing of line current, when the polarity of the capacitor voltage and line current are same, the switching is done in  $t_1$ . Again a resonance circuit consists of L and C. This circuit resonates half cycle and the ON thyristor will turn off in  $t_2$ . The line current will be lag from the TCSC voltage in this situation.

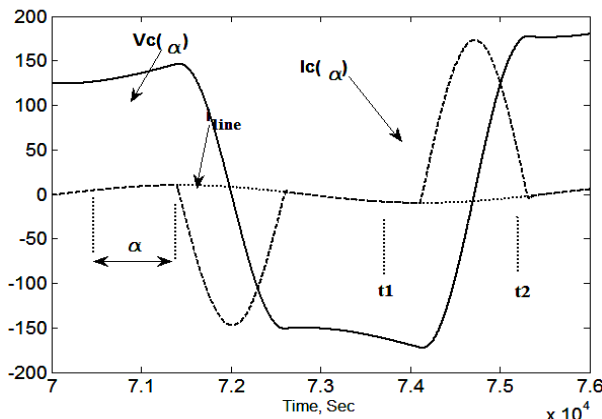

Fig. 4. Switching in inductive mode and half cycle resonance of LC circuit

It is seemed that two conditions like below must be exist:

**First Condition:** The line current must be lead of the capacitor voltage in capacitive mode and must be lag from the capacitive voltage in inductive mode.

If this condition be satisfied then the proper thyristor will turn on in  $\alpha$  delay angle after each zero crossing of the line current. The proper thyristor is determined as:

**Second Condition:** when the capacitor voltage is positive, the positive thyristor (Th+) must be turn on and when the capacitor voltage is negative, the negative thyristor (Th-) must be fired.

A successful switching in both capacitive and inductive mode will be done by combination of these two conditions.

The first condition must be explained more in each capacitive and inductive mode for describing the proposed method of this paper as below:

1-The capacitor voltage and line current always are in different polarity in capacitive mode after each zero crossing of the line current as shown in Fig. 3.

2-In inductive mode, the first condition due to that the capacitor voltage and line current be in same polarity after each zero crossing of

the line current as shown in Fig.4 .

The first condition always is established for capacitive mode because the line current will be lead to the capacitor voltage inherently especially when the thyristors are off and the capacitor is series in the transmission line.

If the first condition is not prepared i.e. the line current is not lag for inductive mode or lead for capacitive mode, what must to do?

When TCSC works in capacitive mode, the line current is lead to the capacitor voltage. If it is decided to switching the TCSC mode from capacitive to inductive at this situation the line current must be lag from the capacitive voltage according to the first condition. Creating this condition is the subject of this paper. This condition will not create normally because of the inherent capacitive behavior of the TCSC. The reference [8] is the only paper that has paid attention to this subject that has more than two half cycle delay.

### 3.Principle of the Proposed Method

The equivalent circuit of TCSC can be considered as a LC parallel circuit as shown in Fig.5. When thyristors are triggered, this circuit will resonate with  $1/(2\pi \cdot \sqrt{LC})$  frequency.

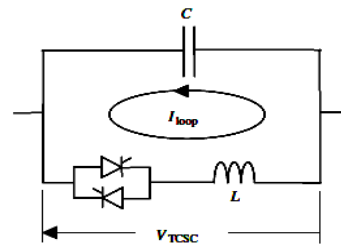

a) TCSC circuit as resonance circuit

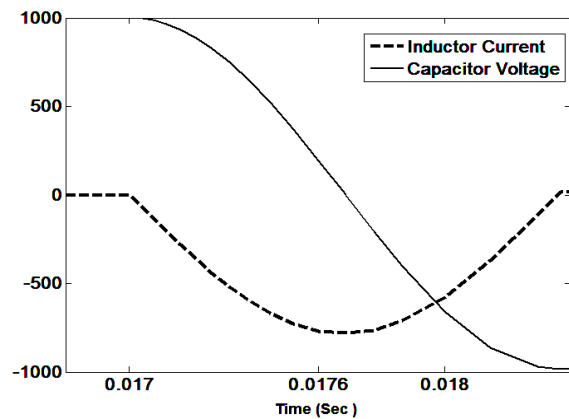

b) Half cycle resonance of LC circuit and the capacitor voltage reversal

Fig. 5. The LC resonance circuit and inversion of the capacitor voltage

The resonance circuit can be described with Equation (4) at beginning of each thyristor firing instance.

$$0 = v_c + LC \frac{dv_c}{dt} \quad (4)$$

$$v_c(0) = V_{C0}, \frac{dv_c}{dt} \Big|_{t=0} = 0$$

As a semiconductor is in the resonance circuit, the circuit will resonant in half cycle and then the thyristor turns off. The result of each resonance is the capacitor voltage reversal according to Equation (5) in both capacitive and inductive mode.

$$v_c(t) = V_{C0} \cdot \cos(\omega_r t) \quad (5)$$

$$i_L(t) = V_{C0} \sqrt{\frac{C}{L}} \cdot \sin(\omega_r t)$$

$$\omega_r = \frac{1}{\sqrt{LC}}$$

This point has been used for creating the first condition in every situation in this paper. If the first condition is not ready for capacitive or inductive mode starting, the capacitor voltage will be reversed by this method in less than half cycle. Then proper condition will obtain.

### The Proposed Algorithm of TCSC Switching and Mode Switching

The firing angle of thyristors is determined on the previous section by two below rules:

**First Rule:** The firing angles and switching commands always do after zero crossing of the line current in  $\alpha$  delay angle in steady state (as synchronous with line current and shown in Fig.2).

**Second Rule:** An extra switching of thyristors can be done for creating proper condition in new operation mode of TCSC before zero crossing of the line current and without synchronization with the line current.

### The proposed algorithm

The above rules are applied for capacitive and inductive mode as below:

- a) If the capacitive mode is purposed and the capacitor voltage and line current are in phase go to step c) for condition changing, else after each zero crossing of the line current:
  - a. If the capacitor voltage is negative then the negative thyristor must be fire in  $\alpha/\omega$  second delay.
  - b. If the capacitor voltage is positive then the positive thyristor must be fire in  $\alpha/\omega$  second delay.
- b) If the inductive mode is wanted and the capacitor voltage and line current are in opposite phase go to step c) for condition changing, else after each zero crossing of the line current:

- a. If the capacitor voltage is negative then the positive thyristor must be fire in  $\alpha/\omega$  second delay.
- b. If the capacitor voltage is positive then the negative thyristor must be fire in  $\alpha/\omega$  second delay.
- c) Condition changing:
  - a. If the capacitive mode has been asked and the a) step condition is not ready, and if the capacitor voltage is positive, the positive thyristor must be have an extra trigger immediately else the negative thyristor must be fire immediately for the capacitor voltage reversing and creating the first condition.
  - b. If the inductive mode has been asked and the b) step condition is not exist, and if the capacitor voltage is positive, the positive thyristor must be turned on immediately else the negative thyristor must be switched on immediately for the capacitor voltage reversing and creating the first condition.

The proposed algorithm is shown in Fig.6 for fast mode switching of TCSC and its normal switching.

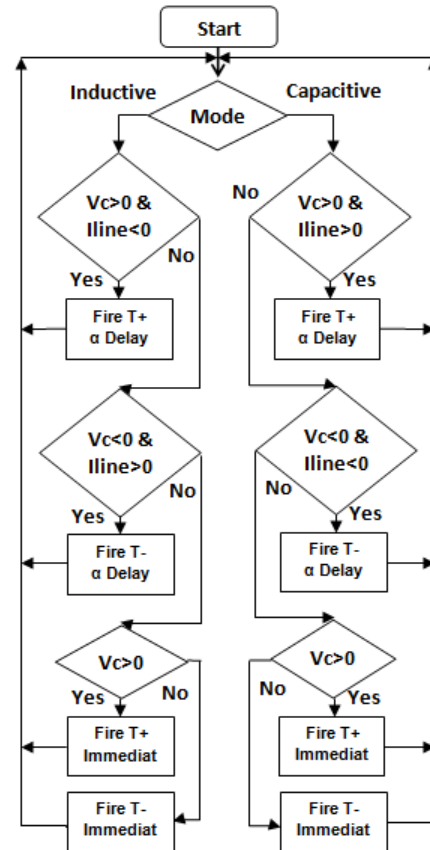

Fig. 6. The proposed algorithm for fast mode switching and normal switching of TCSC

The only requirement of the proposed method is considering the time need for the LC resonance circuit operation.

As mentioned in previous section, the LC circuit resonates half cycle in  $\pi \cdot \sqrt{LC}$  second. This resonant creates proper condition for mode switching of TCSC. Therefore, the proposed method only needs  $\pi \cdot \sqrt{LC}$  time for the half cycle resonance.

Another necessary condition is having a minimum capacitor voltage for initial condition of the LC resonance circuit.

#### 4. Simulations

A circuit is used for simulation of the proposed algorithm as shown in Fig. 7 in MATLAB/SIMULINK. The capacitor is 340uF, inductor is 5.5mH and load is 1Ω and 112mH. The resonance frequency of the LC circuit is 116Hz and  $X_L/X_C$  is equal to 0.184. the power system frequency is 50Hz. The capacitive and inductive mode is simulated in the first for the performance checking of the proposed algorithm. In the next, the mode switching from capacitive to inductive and vice versa is simulated and compared to [8].

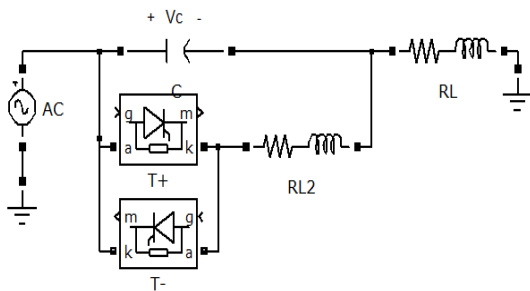

Fig. 7. The simulated circuit

#### First study: capacitive mode

If the line current is lead to the capacitor voltage the first condition is satisfied. In this situation, the switching pulses are applied periodically to the thyristors according the proposed algorithm. The simulation result is shown in Fig. 8.

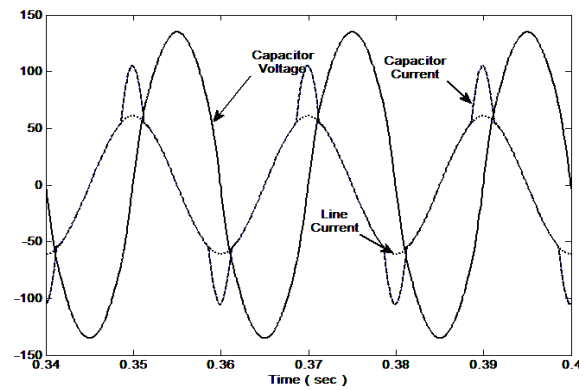

Fig. 8. The current and voltage of TCSC in capacitive mode

#### Second study: inductive mode

On lagging line current to capacitor voltage, the switching pulse will be applied to thyristors and TCSC will be in the inductive mode. The simulation result is shown in Fig. 9 according to the proposed algorithm.

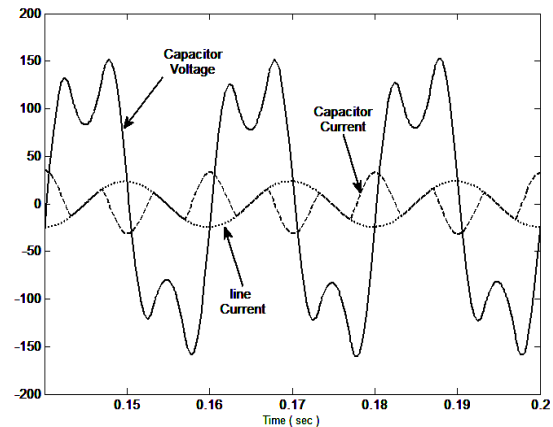

Fig. 9. The current and voltage of TCSC in inductive mode

#### Third study: mode switching from capacitive to inductive

In Fig. 10, TCSC is in capacitive mode in the first. The capacitor voltage and line current are in out of phase after each the zero crossing of the line current (capacitive first condition). But the first condition for inductive mode is not satisfied. An extra switching has been done for changing the conditions according to the proposed algorithm. As shown in Fig. 10, the capacitor voltage is reversed in less than half cycle and the first condition creates for inductive mode.

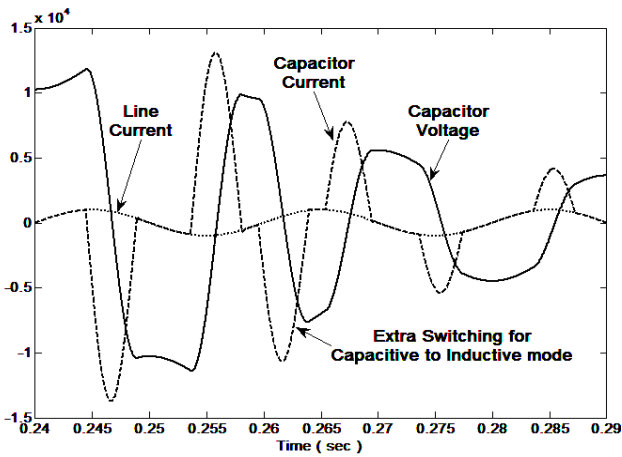

Fig.10. The capacitive mode to inductive mode switching in less than half cycle

The proposed algorithm is compared with reference [8] for mode changing of TCSC from capacitive to inductive mode in Fig. 11. The proposed algorithm of [8] has more than two half cycle delay.

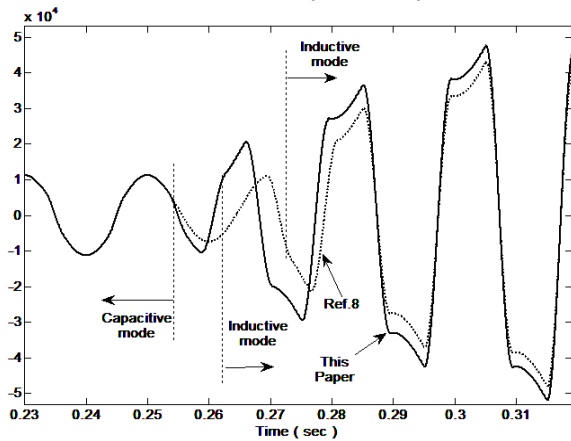

Fig.11. Comparing the proposed method by reference [8] method for capacitive mode to inductive mode switching

A single phase to ground fault is simulated. As shown in Fig.12, TCSC mode is changed from capacitive to inductive mode in a half cycle by the proposed algorithm.

As shown in Fig.12, The proposed algorithm has very good performance and fast dynamic in faults and power oscillations of power systems.

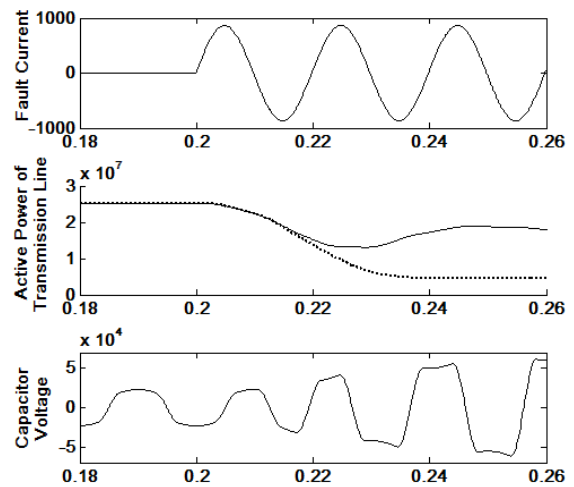

Fig.12. Comparison of active power changing between the proposed algorithm and reference [8] for capacitive to inductive mode switching

It is obvious that faster response of TCSC will important factor in power transient control and damping. These studies will be done in the future works with the proposed algorithm.

#### Fourth study: mode switching from inductive to capacitive

Mode switching from inductive to capacitive is shown in Fig. 13 by the proposed algorithm. An extra thyristor triggering is done at 0.266 second base on the step c) of the proposed algorithm in IV section. This switching causes to inverting the capacitor voltage and creating right condition for capacitive mode operation of TCSC. Any method is not suggested for inductive to capacitor mode switching yet. The only suggestion is blocking the thyristors switching for more than a cycle until the inherent behavior of the capacitor create the leading current for capacitive mode switching.

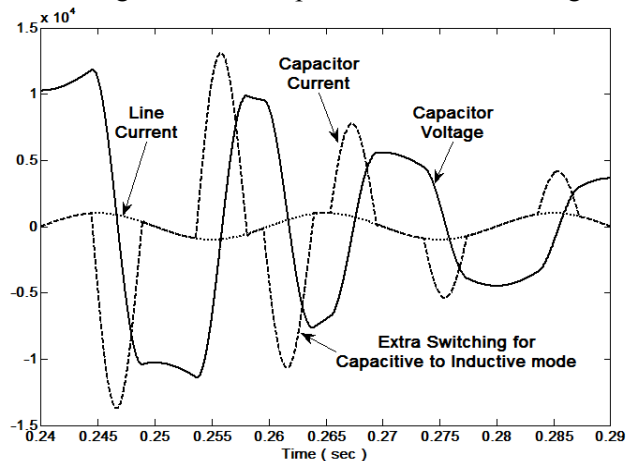

Fig.13. The inductive to capacitive mode switching in less than half cycle

## 5. Conclusion

A new and simple method for mode switching of TCSC from capacitive to inductive mode and vice versa is proposed in this paper. This method was explained in detail and simulated. The first advantage of the proposed algorithm is mode switching of TCSC in less than a half cycle. This solution is proposed for the first time. The second its advantage is that this method decides instantaneously base on the line current and the capacitor voltage therefore it does not have problems of other methods like delay and lose of synchronization. Some methods like PLL base, predictive or estimation methods have problems of more than one cycle delay for prediction or estimation. In the transient conditions those methods may lose their synchronizations and make worse the condition of the power system. But the proposed algorithm decides base on the instant situation of the capacitor voltage and line current and does the best operation in less than half cycle.

Using the proposed method in a rapid power oscillation, simulation results displayed that the proposed method has very good performance and speed in damping of power oscillation.

## References

1. Ph.D Thesis, *Design and coordination between UPFC controllers to improve power oscillation damping*, Majid Nayeripour, Tarbiat Modares University, 2008.
2. Argyrios C. Zolotas, Balarko Chaudhuri, Imad M. Jaimoukha, and Petr Korba, *A study on LQG/LTR control for damping inter-area oscillations in power systems*, IEEE Trans. on control systems technology, vol.15, no.1, jan 2007
3. K.C. SindhuThampatty, M.P.Nandakumar, ElizabethP.Chериан, *Adaptive RTRL based neurocontroller for damping subsynchronous oscillations using TCSC*, Engineering Applications of Artificial Intelligence 24 (2011).
4. Nicklas Johansson, Lennart Ångquist, Hans-Peter Nee, *An Adaptive Controller for Power System Stability Improvement and Power Flow Control by Means of a Thyristor Switched Series Capacitor (TSSC)*, IEEE Trans. On Power Systems, Vol. 25, No. 1, February 2010
5. Dheeman Chatterjee, Arindam Ghosh, *TCSC control design for transient stability improvement of a multi-machine power system using trajectory sensitivity*, Electric Power Systems Research 77 (2007) 470–483
6. Diego C. Savelli, Paulo C. Pellanda, Nelson Martins, Nilo J. P. Macedo, Adriano A. Barbosa, and Guilherme S. Luz, *robust signals for the tcsc oscillation damping controllers of the brazilian north-south interconnection considering multiple power flow scenarios and external disturbances*, IEEE trans on power system, vol. 24, no. 1, pp. 226-236, 2009
7. Ch.Venkatesh T.Deepak K.Rajesh K.Krishna A.K Kamath, *flatness based tcsc controller for transient stability enhancement of power system*, modern electric power systems 2010, wroclaw, poland.
8. Kejun Li, Jianguo Zhao, Chenghui Zhang, and Wei-Jen Lee, *study on mode-switching control of tcsc based on conditional firing of thyristor*, IEEE trans. on power delivery, vol. 26, no. 2, april 2011.
9. S. A. Zaid, *thyristor firing circuit synchronization techniques in thyristor controlled series capacitors*, IEEE 978-1-4244-8930-5/11, 2011

**Majid Nayeripour** was born in 1971. He received his B.S. degree in electronic Eng. from Guilan University and M.S degree in Electrical Eng. from Esfahan University of Technology and PhD degree in Electrical Eng. Form Tarbiat Modares University, Tehran, Iran. Currently, he is an Assistant Professor with the Shiraz University of Technology. His research interests include FACTS devices, Power Quality and impact of DGs on power system.

**Mahdi Mansuri** was born in 1975. He received his B.S. degree in electronic Eng. and M.S degree in Electronic Power both from Sharif University of Technology. He has ten years experience in Yazd regional electric company in technical office of transmission protection. He is PhD student in Shiraz University of Technology. His research interests include FACTS devices, Power Quality and Power system Protection.